

TOBY DVR5 OIL CONTROL & SAFETY VALVE

TECHNICAL HANDBOOK

Principle of Operation

The **Toby DVR5 Oil Control Valve** is a multi function unit for maintaining a constant oil level, regulating the oil flow and providing a safety shut off for oil heating appliances. The fuel enters via the filter and the inlet valve into the oil control body. The rising oil level in the oil control lifts the float and when the oil has reached the 'oil level' mark, the inlet valve is closed. Should the inlet valve 'let by' the oil level in the control continues to rise until the safety level is reached at which point the safety shut off system is triggered and the inlet valve is forcibly closed. To reset the valve the reset lever (R – see page 5) must be **lifted**. With the DVR5 control the oil flow must be adjusted manually by turning the control knob clockwise to reduce the rate and anticlockwise to increase the rate. Turn to the 'O' position for turning the oil supply OFF.

DVR OIL CONTROL- Normal Annual Servicing

The Toby DVR5 Oil Control valve requires annual servicing. Additional cleaning may prove necessary if the valve has been used with unclean fuel.

The following sequence should be carried out during the annual service;

- 1) Tap the actuating lever, with the control knob set at the highest position. In this way, any slight accumulation of dirt in and around the metering stem slot will be displaced. (See picture 1)
- 2) Remove any carbon deposit (cracked oil) from the burner feed pipe to ensure unobstructed oil flow from the valve to the burner. (Always refer to appliance manufacturers instructions)
- 3) Remove and clean or replace the filter (see pictures 2 & 3)
- 4) Remove the draining screw (see picture 4) and rinse the valve through with clean fuel oil until clear oil emerges at the point of drainage.
- 5) If water is found inside the oil control, it is advisable to also clean the oil supply pipe between the oil control and the burner.



1



2



3



4

After these operations have been carried out the appliance should be run for at least 15 minutes with the valve on low setting and then 15 minutes on high setting.

Only if the smoke number and CO₂ ratio required are not realised should the oil flow rate be adjusted. The measures to be taken in this case are described under **Oil Flow Adjustment** (below) and in the table 'Fault Finding & Maintenance Measures' (page 4).

DVR5 OIL CONTROL-Oil Flow Adjustment

When the heating appliance is commissioned it should not be required to adjust the oil control, however sometimes it proves necessary.

Oil flow rate adjustments are necessary if the minimum flue draught required is not available or if the fuel oil used is not of the viscosity specified (mm²/s or cSt) on the data plate of the oil control.

Adjustment of the oil flow is only to be conducted by an OFTEC qualified technician when the heating device is in operation.

After the oil flow has been adjusted at least 5 minutes must be allowed for the flame to stabilise to the newly-adjusted flow before any further adjustment is undertaken.

As a general rule, a quarter-turn of the flow rate adjustment screws suffices to make any necessary correction. Along-side both the high and low flow adjustment screws (sealed with red paint) are arrows with + and – signs indicating in which direction the screws must be turned so as to increase or decrease the high or low oil flow.

The high flame must be adjusted first with the stove running at maximum capacity, after which the low flame is adjusted. If the flow is controlled by means of a ZR Electric Top with an externally mounted thermostat the low flame must be adjusted via the thermostat actuating pin (see picture 7). Turning the pin clockwise decreases, turning it anti-clockwise increases the flow. When checking the low flow via the thermostat actuating pin, the pin must be pressed down on to the top of the hexagonal brass nut.

See also the ZR electric top instructions.

Adjustment of the HIGH fire rate. (See picture 5).

The combustion must not cause soot or rumbling.

Exact adjustment can only be carried out only when a smoke sampling pump and a draught gauge are used.



5

Adjustment of the LOW fire rate. (See picture 6)

The flame must stabilise all round the pot below the lowest ring when on the LOW fire rate. Note; in the case of the DVR5 oil control the HIGH fire rate must be adjusted first; before the LOW fire rate.



6

Adjustment of the LOW flow via the thermostat pin. **(see picture 7)**
This adjustment is necessary only when the oil flow is thermostatically controlled. Turning the pin clockwise decreases, turning the pin anti-clockwise increases the minimum flow.
When the pin is pressed down, the low flame must just burn all round the burner pot under the low fire ring.
See also ZR electric top instructions.



7

Top cover removal. **(see picture 8)**



8

Removal of the float assembly. **(see picture 9)**
Remove the fixing screw as shown.



9

Lifting out the complete float assembly. **(See picture 10).**
When the fixing screws have been removed, the complete float assembly can be lifted out. If the float assembly is damaged and must be replaced it is recommended that a new DVR5 oil control is fitted.



Cleaning the metering stem slot. **(see picture 11)**
This must only be done carefully with a soft non-metallic instrument.
The slot must not be enlarged and the 'O' ring not damaged.



11

An anti-overheat devices may be fitted in the DVR5 oil control to offer extra protection. The device may have been specified by the heating or stove appliance manufacture. The anti-overheating safety device is fitted during manufacture of the oil control valve.
The device closes and locks the inlet valve in the case of the ambient temperature exceeding 100°C. In order to reset the float control after the safety device has been tripped, the complete anti-overheating device must be replaced.

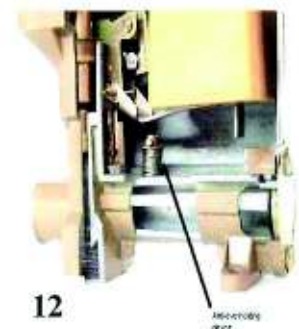

12

Points To Be Observed With Regard To The Oil Supply Line.

If the oil line supply pressure at the oil control is greater than 3.5m head (4psi) then a pressure reducing valve must be fitted in the pipeline leading to the DVR5 oil control. When fitting a pressure reducing valve, care must be taken that the pipe from the pressure reducing to the DVR5 is on a constant upward slant to the DVR5 in order to prevent any air locks. Within the oil supply system, the oil control is not the only part that can affect the correct functioning of the appliance. The correct choice of all the other components, filters, fire valves etc are also important. For this reason, when a problem occurs, the complete oil supply installation should be checked to ascertain whether it does indeed deliver the required amount of oil to the DVR5 oil float control.

DVR5 Oil Control Valve - Fault Finding & Maintenance Measures.

Possible Defects	Causes	Counter-measures
No oil flows to the vaporising burner or oil control	Oil tank empty Service valve closed Oil control switched to safety position	Fill up with oil Open service valve Lift the control lever (R)
Too little oil flows to the vaporising burner	Burner feed pipe coked Stove is on a tilt Oil Control is dirty Fuel used is too viscous	Remove oil coke Stand the stove horizontally Clean oil control (pictures 1-4) Increase flow (pictures 5-8)
Too much oil flows to the Vaporising burner (stove gets sooty and noisy (rumbles)	Too much oil in burner prior to ignition. Flue draught inadequate or flue is getting a false draught. Flow too high	Reduce fuel to burner prior to ignition. Measure draughts. Check against stove manufacturer's specification. Prevent false draughts Decrease flow (pictures 5-8)
Oil flow to the vaporising burner fluctuates	Dirty metering stem slot Air in supply line	Tap thermostat actuating pin as shown (picture 1) Clean oil control (pictures 1-4)
Safety device is constantly tripped	Oil control very dirty	Clean oil control (pictures 1-4)
Stove is turned off and oil still flows to the vaporising burner	Control knob of the oil control is pulled upwards by an additional remote knob Washer on metering stem is defective Dirty oil control	Lengthen remote arm or make it move more easily so that the stroke movement of the control knob is not hindered. Renew metering stem washer Clean oil control (pictures 1-4)

Should it not be possible to put the DVR5 oil control back into working order, please contact the stove/heating appliance manufacturer for a replacement part or assistance.

DVR series Oil Float Controls (Sectional View)

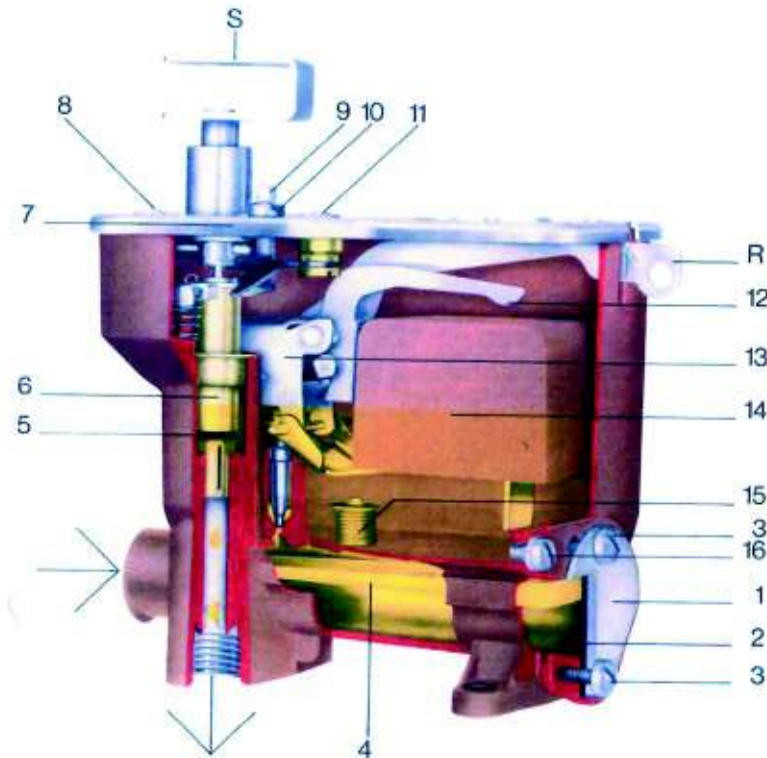

1) Filter cover	10) Fixing screw
2) Filter Washer	11) Low flame adjustment screw
3) Filter screw	12) Safety cut off lever
4) Filter	13) Float assembly
5) Washer	14) Microcell float
6) Metering stem	15) Overheating safety device (only fitted if specified)
7) Lid assembly	16) Draining screw
8) High flame adjustment screw	R) Reset lever
9) Actuating pin	S) Control knob (either steel or plastic)

Instruction Leaflet for Toby ZR electric top

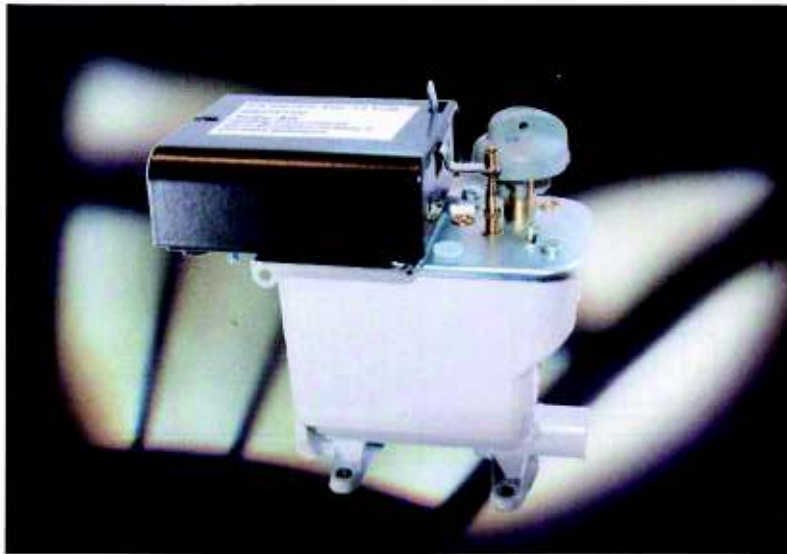

The ZR electric top is available 6 versions

Article number	Designation	Article number	Designation
ZR01012V	ZR electric top 12V	ZR02012V	ZR electric top 12V with switch (*)
ZR01024V	ZR electric top 24V	ZR02024V	ZR electric top 24V with switch (*)
ZR01240V	ZR electric top 240V	ZR02240V	ZR electric top 240V with switch (*) (*) Special production

- All versions are fitted with a manual control lever (L). If the lever is placed in the position (Z) then the flow rate can be adjusted by the knob (K). With the lever in position (Z) the appliance can be satisfactorily operated during a power failure.
- Versions are available with or without switch. The switch is for controlling the fan operation on fan assisted appliances.
- Versions are available for 12 volt, 24 volt or 240 volt operation.
- The ZR electric top is supplied for installation on the Toby DVR5 oil control valve with thermostat pin (Fig. 6 - P1 + P2).



Figure 1

Function of the ZR electric top on the Toby DVR5 with thermostat pin.

When the Toby ZR electric top is fitted onto a Toby DVR5 it automatically controls the oil flow rate of the oil fired appliance by means of an external room thermostat or cooker thermostat. During the running cycle the ZR electric top automatically adjusts the oil from high fire to low fire and low fire to high fire depending on the thermostat heating requirements. In the event of a power failure the unit automatically sets to low fire. **Figure 1** during power failures the manual latch lever (L) can be used to override the electric operation and allow for manual flow rate adjustment by means of the knob (K). The ZR electric top with switch can be used to operate a fan on fan assisted appliances.

Adjusting the operating arm limits.

Fig. 5 a screwdriver is used to turn screw (M) to adjust the setting (W) between the operating arm (P2) and the thermostat pin (P1). In '**Detail Fig 5**' for the basic adjustment it is necessary for a distance between (A) and (B) of a minimum of 1.5 mm and maximum of 2.0 mm. Turn the screw (M) clockwise to reduce the flow adjustment delay and anticlockwise to increase flow adjustment delay.

Electrical connections

Fig. 2 shows the wiring arrangements. The cables are fed through the grommets (C) in the end of the ZR housing and retained by the strain relief (D) inside the housing. **Fig. 3** shows the wiring terminal block. Connections should be made in accordance with Pattern 1, for appliances without fan assistance, Pattern 2 and 3 for high and low voltage operation with fan. For 240 volt applications the earth connection (PE, **Fig. 6**) must be made. On fan switch models it is possible to reduce the speed of the fan on low fire by the addition of a resistor 'R', see Pattern 2 and 3 at cable connection no 6. Please check before connection that the voltage of the ZR electric top is the correct version for the appliance voltage.

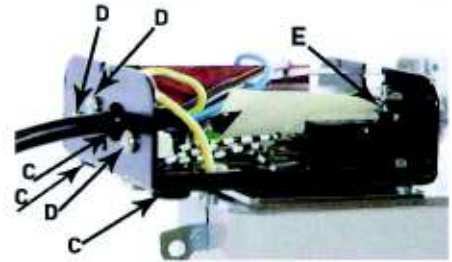
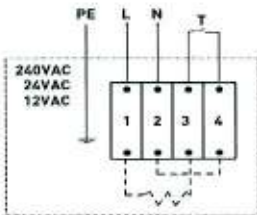
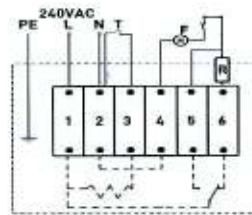

Figure 2

Pattern 1



Pattern 2



Pattern 3

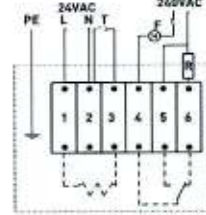

Figure 3

Pattern information:

L= live supply
N= neutral connection
PE= earth connection
F= fan connection
R= resistor
T= thermostat

Assembly

The ZR electric top is usually mounted by Toby onto the oil control valve and then supplied to the customer. If a ZR electric top must be replaced by the customer, proceed as follows. Remove screw (S) in **Fig. 4** and remove the cover (G) in **Fig. 6**. The adaptor plate (M) is fastened onto the oil control with the 2 screws (H). The ZR electric top is then fixed onto the adaptor plate with the 3 screws (V). Check and adjust if necessary that the pin (P2) is directly above the thermostat pin (P1) in **Fig. 6** before tightening screws (V). Always check the local by-laws and manufacturers instructions before assembly.

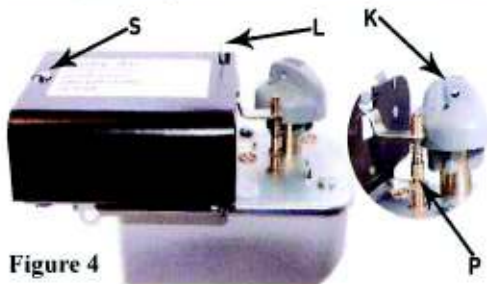

Figure 4

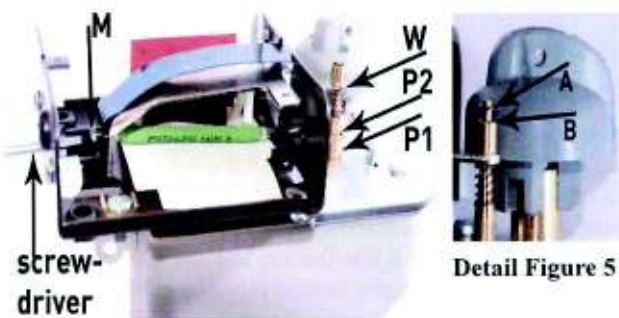

Figure 5

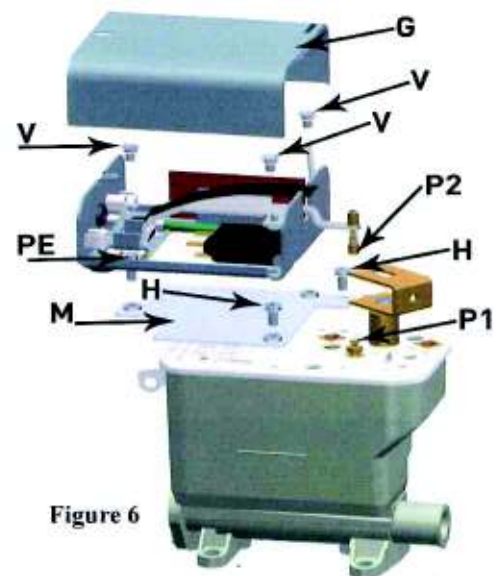

Figure 6

Setting the fan switching point on the ZR electric top

The fan timings of ZR models with a switch can be adjusted with screw (E) on **Fig. 2**. The screw (E) is normally set to start the fan soon after the oil control leaves the low fire position. If you wish the fan to be started later in the 'up' cycle, turn the screw clockwise. Bringing the fan on later in the 'up' cycle also turns the fan off earlier in the 'down' cycle due to the fixed switching differential. Adjust the screw only by a 1/4 turn at a time and check the results before further adjustment. Do not adjust the screw to turn the fan on too early on the 'up' cycle as this may prevent the fan from turning off at the end of the 'down' cycle.

Operation

After installing and connecting the room thermostat the ZR electric top is ready for use. Refer to the appliance manufacturers instructions for lighting the appliance. When putting the appliance 'out of operation' turn the thermostat off to switch off the power supply to the ZR electric top.